

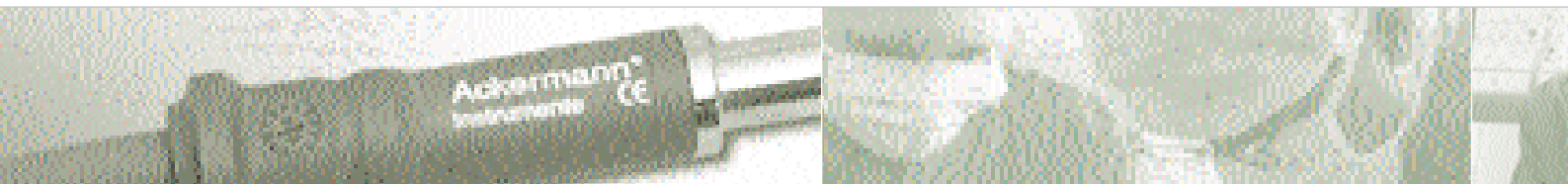

ENDOSKOPE, ELEKTRODEN, SAUG-SPÜLELEMENTE
ENDOSCOPES, ELECTRODES, SUCTION IRRIGATION SYSTEMS

11



OPTIKEN | SCOPES

EAGLE VISION AUTOKLAVIERBARE ENDOSKOPE | EAGLE VISION AUTOCLAVABLE SCOPES

Direktverriegelung mit Adapter 15-1702 DC
 Direct Coupling with adapter 15-1702 DC

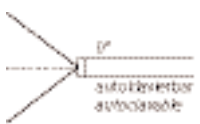

| | | |
|------------------|------------------------------------------------------------------------------------------------------------------------------------------------------|------------|
| 11-1120-4 | Laparoskop, autoklavierbar, Hochleistungslinse, <i>Laparoscope, fully autoclavable, high performance lens,</i> | 4 mm 0° |
| 11-1120 | Laparoskop, autoklavierbar, Hochleistungslinse, <i>Laparoscope, fully autoclavable, high performance lens,</i> | 5 mm 0° |
| 11-1120G | Laparoskop, autoklavierbar, Hochleistungslinse, Gold Version, <i>Laparoscope, fully autoclavable, high performance lens, gold version,</i> | 5 mm 0° |



| | | |
|-----------------|------------------------------------------------------------------------------------------------------------------------------------------------------|-------------|
| 11-1125 | Laparoskop, autoklavierbar, Hochleistungslinse, <i>Laparoscope, fully autoclavable, high performance lens,</i> | 5 mm 30° |
| 11-1125G | Laparoskop, autoklavierbar, Hochleistungslinse, Gold Version, <i>Laparoscope, fully autoclavable, high performance lens, gold version,</i> | 5 mm 30° |



| | | |
|-----------------|------------------------------------------------------------------------------------------------------------------------------------------------------|-------------|
| 11-1126 | Laparoskop, autoklavierbar, Hochleistungslinse, <i>Laparoscope, fully autoclavable, high performance lens,</i> | 5 mm 45° |
| 11-1126G | Laparoskop, autoklavierbar, Hochleistungslinse, Gold Version, <i>Laparoscope, fully autoclavable, high performance lens, gold version,</i> | 5 mm 45° |



OPTIKEN | SCOPES

EAGLE VISION AUTOKLAVIERBARE ENDOSKOPE | EAGLE VISION AUTOCLAVABLE SCOPES



11

| | | | | | | | | | | |
|--------------------|--------------------------------------------------------------------------------------------------------------------------------------------------------------------------------------------------------------------------------------------------------------------------------------------------------------------------------------------------------------------------------------------------------------------------------------------------------------------------------------------------------------------------------------------------------------------------------------------------------------------------------------------------------------|----------------|----------------------------------------------------------------------------------------------------------------------|---------------|--------------------|-------------------------------------------------------------------------------------------------------------------------------------------------------------|--------------|-----------------|-------------------------------------------------------------------------------------------------------------------------------------------------------------|--------------|
| | <table border="1"> <tr> <td>11-1130</td> <td>Laparoskop, autoklavierbar, Hochleistungslinse, <i>Laparoscope, fully autoclavable, high performance lens,</i></td> <td>10 mm 0°</td> </tr> <tr> <td>11-1130-180</td> <td>Laparoskop, autoklavierbar, Hochleistungslinse, 180 mm, <i>Laparoscope, fully autoclavable, high performance lens, 180 mm,</i></td> <td>10 mm 0°</td> </tr> <tr> <td>11-1130G</td> <td>Laparoskop, autoklavierbar, Hochleistungslinse, Gold Version, <i>Laparoscope, fully autoclavable, high performance lens, gold version,</i></td> <td>10 mm 0°</td> </tr> </table> | 11-1130 | Laparoskop, autoklavierbar, Hochleistungslinse, <i>Laparoscope, fully autoclavable, high performance lens,</i> | 10 mm 0° | 11-1130-180 | Laparoskop, autoklavierbar, Hochleistungslinse, 180 mm, <i>Laparoscope, fully autoclavable, high performance lens, 180 mm,</i> | 10 mm 0° | 11-1130G | Laparoskop, autoklavierbar, Hochleistungslinse, Gold Version, <i>Laparoscope, fully autoclavable, high performance lens, gold version,</i> | 10 mm 0° |
| 11-1130 | Laparoskop, autoklavierbar, Hochleistungslinse, <i>Laparoscope, fully autoclavable, high performance lens,</i> | 10 mm 0° | | | | | | | | |
| 11-1130-180 | Laparoskop, autoklavierbar, Hochleistungslinse, 180 mm, <i>Laparoscope, fully autoclavable, high performance lens, 180 mm,</i> | 10 mm 0° | | | | | | | | |
| 11-1130G | Laparoskop, autoklavierbar, Hochleistungslinse, Gold Version, <i>Laparoscope, fully autoclavable, high performance lens, gold version,</i> | 10 mm 0° | | | | | | | | |
| | <table border="1"> <tr> <td>11-1135</td> <td>Laparoskop, autoklavierbar, Hochleistungslinse, <i>Laparoscope, fully autoclavable, high performance lens,</i></td> <td>10 mm 30°</td> </tr> <tr> <td>11-1135-180</td> <td>Laparoskop, autoklavierbar, Hochleistungslinse, 180 mm, <i>Laparoscope, fully autoclavable, high performance lens, 180 mm,</i></td> <td>10 mm 30°</td> </tr> <tr> <td>11-1135G</td> <td>Laparoskop, autoklavierbar, Hochleistungslinse, Gold Version, <i>Laparoscope, fully autoclavable, high performance lens, gold version,</i></td> <td>10 mm 30°</td> </tr> </table> | 11-1135 | Laparoskop, autoklavierbar, Hochleistungslinse, <i>Laparoscope, fully autoclavable, high performance lens,</i> | 10 mm 30° | 11-1135-180 | Laparoskop, autoklavierbar, Hochleistungslinse, 180 mm, <i>Laparoscope, fully autoclavable, high performance lens, 180 mm,</i> | 10 mm 30° | 11-1135G | Laparoskop, autoklavierbar, Hochleistungslinse, Gold Version, <i>Laparoscope, fully autoclavable, high performance lens, gold version,</i> | 10 mm 30° |
| 11-1135 | Laparoskop, autoklavierbar, Hochleistungslinse, <i>Laparoscope, fully autoclavable, high performance lens,</i> | 10 mm 30° | | | | | | | | |
| 11-1135-180 | Laparoskop, autoklavierbar, Hochleistungslinse, 180 mm, <i>Laparoscope, fully autoclavable, high performance lens, 180 mm,</i> | 10 mm 30° | | | | | | | | |
| 11-1135G | Laparoskop, autoklavierbar, Hochleistungslinse, Gold Version, <i>Laparoscope, fully autoclavable, high performance lens, gold version,</i> | 10 mm 30° | | | | | | | | |
| | <table border="1"> <tr> <td>11-1136</td> <td>Laparoskop, autoklavierbar, Hochleistungslinse, <i>Laparoscope, fully autoclavable, high performance lens,</i></td> <td>10 mm 45°</td> </tr> <tr> <td>11-1136G</td> <td>Laparoskop, autoklavierbar, Hochleistungslinse, Gold Version, <i>Laparoscope, fully autoclavable, high performance lens, gold version,</i></td> <td>10 mm 45°</td> </tr> </table> | 11-1136 | Laparoskop, autoklavierbar, Hochleistungslinse, <i>Laparoscope, fully autoclavable, high performance lens,</i> | 10 mm 45° | 11-1136G | Laparoskop, autoklavierbar, Hochleistungslinse, Gold Version, <i>Laparoscope, fully autoclavable, high performance lens, gold version,</i> | 10 mm 45° | | | |
| 11-1136 | Laparoskop, autoklavierbar, Hochleistungslinse, <i>Laparoscope, fully autoclavable, high performance lens,</i> | 10 mm 45° | | | | | | | | |
| 11-1136G | Laparoskop, autoklavierbar, Hochleistungslinse, Gold Version, <i>Laparoscope, fully autoclavable, high performance lens, gold version,</i> | 10 mm 45° | | | | | | | | |
| | <table border="1"> <tr> <td>11-1137</td> <td>Laparoskop, autoklavierbar, Hochleistungslinse,* <i>Laparoscope, fully autoclavable, high performance lens,*</i></td> <td>6,5 mm 30°</td> </tr> </table> <p>* für Doppelstich-Sterilisation <i>for sterilisation double puncture</i></p> | 11-1137 | Laparoskop, autoklavierbar, Hochleistungslinse,* <i>Laparoscope, fully autoclavable, high performance lens,*</i> | 6,5 mm 30° | | | | | | |
| 11-1137 | Laparoskop, autoklavierbar, Hochleistungslinse,* <i>Laparoscope, fully autoclavable, high performance lens,*</i> | 6,5 mm 30° | | | | | | | | |
| | <table border="1"> <tr> <td>11-1138</td> <td>Laparoskop, autoklavierbar, 100000 Pix, Fiberskop <i>Laparoscope, fully autoclavable, 100.000 pix, fiberscope</i></td> <td>5,0 mm 0°</td> </tr> </table> | 11-1138 | Laparoskop, autoklavierbar, 100000 Pix, Fiberskop <i>Laparoscope, fully autoclavable, 100.000 pix, fiberscope</i> | 5,0 mm 0° | | | | | | |
| 11-1138 | Laparoskop, autoklavierbar, 100000 Pix, Fiberskop <i>Laparoscope, fully autoclavable, 100.000 pix, fiberscope</i> | 5,0 mm 0° | | | | | | | | |

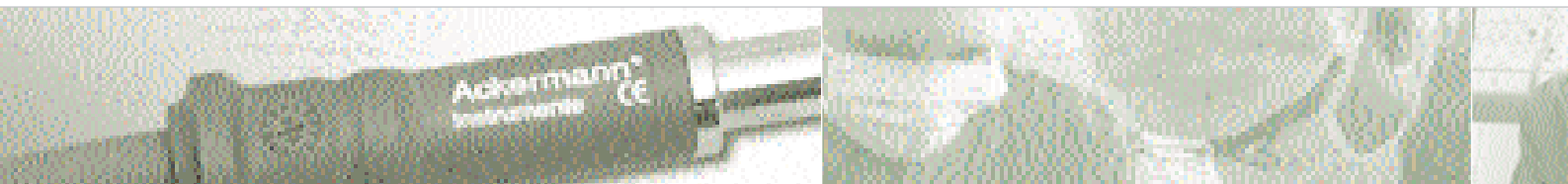

OPTIKEN | SCOPES

OPERATIONS LAPAROSKOPE | OPERATING LAPAROSCOPES

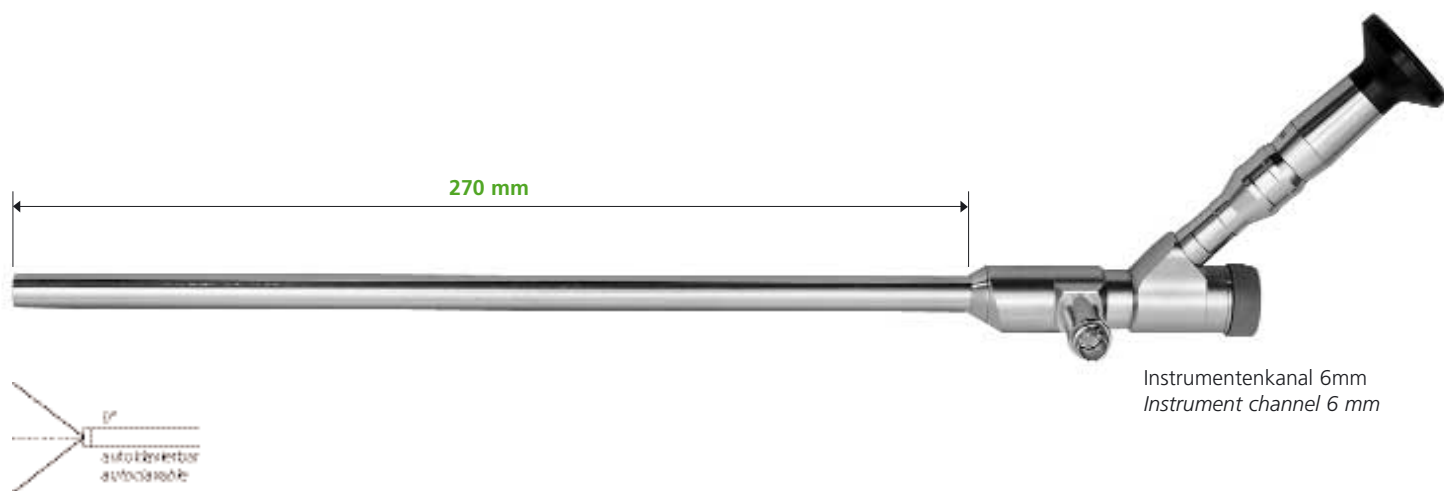

Instrumentenkanal 6mm
Instrument channel 6 mm



| | | |
|-----------------|---------------------------------------------------------------------------------------------------------------------------------|-------------|
| 10-1140 | Operations-Laparoskop mit 45° Ansicht, <i>Operating Laparoscope with 45° view,</i> | 10 mm 0° |
| 10-1140G | Operations-Laparoskop mit 45° Ansicht, Gold Version, <i>Operating Laparoscope with 45° view, gold version,</i> | 10 mm 0° |
| 10-1145 | Operations-Laparoskop mit 90° Ansicht, <i>Operating Laparoscope with 90° view,</i> | 10 mm 0° |
| 10-1145G | Operations-Laparoskop mit 90° Ansicht, Gold Version, <i>Operating Laparoscope with 90° view, gold version,</i> | 10 mm 0° |



ADAPTER FÜR LICHTLEITKABEL | ADAPTERS FOR LIGHT GUIDES

LICHTQUELLEN-SEITE
LIGHTSOURCE-SIDE

ENDOSKOP-SEITE
ENDOSCOPE-SIDE



11-1147-100 Ackermann® / Storz®
Ackermann® / Storz®



11-1146-100



11-1147-100HS Ackermann® / Storz® mit Hitzeschutz*
Ackermann® / Storz® with heat shield*



11-1146-200



11-1147-200 Wolf
Wolf



11-1147-200HS Wolf mit Hitzeschutz*
Wolf with heat shield*



11-1147-300 ACM / Circon
ACM / Circon

11-1146-300



11-1147-300HS ACM / Circon mit Hitzeschutz*
ACM / Circon with heat shield*



11-1147-400 Olympus
Olympus



11-1147-400HS Olympus mit Hitzeschutz*
Olympus with heat shield*



11-1147-400OLY Olympus Lichtquellen Booster
Olympus light source booster



11-1147-500 Pentax
Pentax

11-1147-500HS Pentax mit Hitzeschutz*
Pentax with heat shield*

11-1147-800 Stryker
Stryker

11-1147-800HS Stryker mit Hitzeschutz*
Stryker with heat shield*

* für 300W und 600W Xenon | for 300W and 600W Xenon



10-16000CB Lichtkabel Tester,
Power meter for fibers Ackermann®
Storz®

10-16000CBOLY Lichtkabel Tester,
Power meter for fibers Olympus®

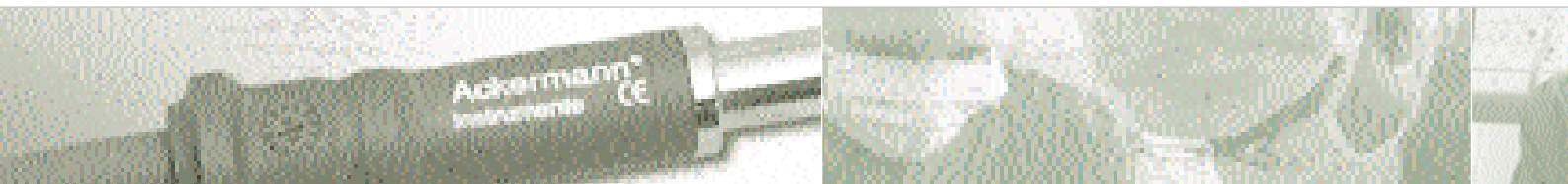

LICHTLEITKABEL | LIGHT GUIDES



Hochverdichtetes Ackermann-Kabel
High compressed Ackermann cable



30 % mehr Licht
30 % more light

Standard-Kabel des Wettbewerbs
Conventional cable of competitors



Weniger Licht durch Hohlräume
Less light due to spaces

| | | |
|----------------|-----------------------------------------------------------------------------------------------------------------------------------------------------------------------------------------------|----------------|
| 11-1148 | Hochleistungslichtleiter, hitzegeschützt für 300 W und 600 W Xenon Lichtquellen (SH Modell), <i>High performance light cable, heat shielded for 300 and 600 W Xenon bulbs (SH model),</i> | 6,0 mm x 2,3 m |
| 11-1149 | Hochleistungslichtleiter, hitzegeschützt für 300 W und 600 W Xenon Lichtquellen (SH Modell), <i>High performance light cable, heat shielded for 300 and 600 W Xenon bulbs (SH model),</i> | 6,0 mm x 3,0 m |
| 11-1150 | Hochleistungslichtleiter, PF Performance, <i>High performance light cable, PF Performance,</i> | 3,5 mm x 1,8 m |
| 11-1151 | Hochleistungslichtleiter, PF Performance, <i>High performance light cable, PF Performance,</i> | 3,5 mm x 2,3 m |
| 11-1152 | Hochleistungslichtleiter, PF Performance, <i>High performance light cable, PF Performance,</i> | 3,5 mm x 3,0 m |
| 11-1159 | Fiber Lichtleiter, Standard, <i>Fibre light cable, standard,</i> | 4,8 mm x 2,3 m |
| 11-1160 | Fiber Lichtleiter, Standard, <i>Fibre light cable, standard,</i> | 4,8 mm x 1,8 m |
| 11-1161 | Hochleistungs-Lichtleiter, hitzegeschützt für 300 W und 600 W Xenon Lichtquellen (SH Modell), <i>High performance light cable, heat shielded for 300 and 600 W Xenon bulbs (SH model),</i> | 4,8 mm x 3,0 m |



LICHTLEITKABEL | LIGHT GUIDES



Hochverdichtetes Ackermann-Kabel
High compressed Ackermann cable



30 % mehr Licht
30 % more light

Standard-Kabel des Wettbewerbs
Conventional cable of competitors



Weniger Licht durch Hohlräume
Less light due to spaces

| | | |
|---------|----------------------------------------------------------------------------------------------------------------------------------------------------------------------------------------------|----------------|
| 11-1162 | Hochflexibler Lichtleiter, Standard, <i>Superflexible light cable, standard,</i> | 3,5 mm x 2,3 m |
| 11-1163 | Hochflexibler Lichtleiter, Standard, <i>Superflexible light cable, standard,</i> | 3,5 mm x 1,8 m |
| 11-1164 | Flüssiglichtleitkabel , neue Flüssigkeit, mehr Licht, <i>Fluid light cable, new fluid - more light,</i> | 5,0 mm x 2,3 m |
| 11-1165 | Flüssiglichtleitkabel , neue Flüssigkeit, mehr Licht, <i>Fluid light cable, new fluid - more light,</i> | 5,0 mm x 1,8 m |
| 11-1166 | Hochflexibler Lichtleiter, Standard, <i>Superflexible light cable, standard,</i> | 3,5 mm x 3,0 m |
| 11-1167 | Hochleistungslichtleiter, hitzegeschützt für 300 W und 600 W Xenon Lichtquellen (SH Modell), <i>High performance light cable, heat shielded for 300 and 600 W Xenon bulbs (SH Model),</i> | 4,8 mm x 2,3 m |
| 11-1168 | Hochleistungslichtleiter, hitzegeschützt für 300 W und 600 W Xenon Lichtquellen (SH Modell), <i>High performance light cable, heat shielded for 300 and 600 W Xenon bulbs (SH Model),</i> | 4,8 mm x 1,8 m |
| 11-1169 | Fiber Lichtleiter, Standard, <i>Fibre light cable, standard,</i> | 4,8 mm x 3,0 m |

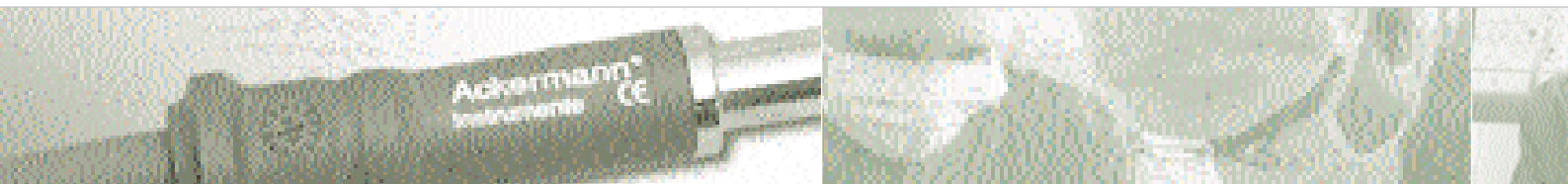

ELEKTRODEN | CAUTERIES



| | | |
|----------------|-----------------------------------------------------------------------------|-----------------------------------------|
| 11-1170 | Elektrode, Spatelspitze, HF, Cauteries, spatula tip, HF-port, | 330 mm Arbeitslänge working length |
| 11-1175 | Elektrode, L-Haken-Spitze, HF, Cauteries, L-hook tip, HF-port, | 330 mm Arbeitslänge working length |
| 11-1180 | Elektrode, Messerspitze, HF, Cauteries, knife tip, HF-port, | 330 mm Arbeitslänge working length |
| 11-1185 | Elektrode, J-Hakenspitze, HF, Cauteries, J-hook tip, HF-port, | 330 mm Arbeitslänge working length |
| 11-1188 | Sichel-Elektrode, 5 mm, adaptierbar Sichel electrode, 5 mm, adaptable | 330 mm Arbeitslänge working length |
| 11-1195 | Elektrode, Saug-Spitze, HF, Cauteries, suction coagulation tip, HF-port, | 330 mm Arbeitslänge working length |
| 11-1200 | Elektrode, Nadel-Spitze, HF, Cauteries, needle tip, HF-port, | 330 mm Arbeitslänge working length |
| 11-1205 | Elektrode, Konus-Spitze, HF, Cauteries, cone tip, HF-port, | 330 mm Arbeitslänge working length |
| 11-1210 | Elektrode, Knopf-Spitze, HF, Cauteries, button tip, HF-port, | 330 mm Arbeitslänge working length |



ELEKTRODEN | CAUTERIES

11



| | | |
|-----------------|----------------------------------------------------------------------------------------|-----------------------------------------|
| 11-1170C | Elektrode, Spatelspitze, mit Keramik Spitze, Cauteries, spatula tip, with ceramic tip, | 330 mm Arbeitslänge working length |
|-----------------|----------------------------------------------------------------------------------------|-----------------------------------------|



| | | |
|-----------------|-----------------------------------------------------------------------------------------|-----------------------------------------|
| 11-1175C | Elektrode, L-Haken-Spitze, mit Keramik Spitze, Cauteries, L-hook tip, with ceramic tip, | 330 mm Arbeitslänge working length |
|-----------------|-----------------------------------------------------------------------------------------|-----------------------------------------|



| | | |
|-----------------|----------------------------------------------------------------------------------------|-----------------------------------------|
| 11-1185C | Elektrode, J-Hakenspitze, mit Keramik Spitze, Cauteries, J-hook tip, with ceramic tip, | 330 mm Arbeitslänge working length |
|-----------------|----------------------------------------------------------------------------------------|-----------------------------------------|

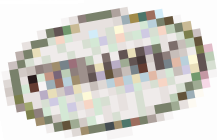

| | | |
|----------------|---------------------------------------------------------------|-----------------------------------------|
| 11-1178 | Spatel Elektrode, adaptierbar Spatula electrode, adaptable | 330 mm Arbeitslänge working length |
|----------------|---------------------------------------------------------------|-----------------------------------------|



| | | |
|----------------|---------------------------------------------------------------|-----------------------------------------|
| 11-1179 | L-Haken Elektrode, adaptierbar L Hook electrode, adaptable | 330 mm Arbeitslänge working length |
|----------------|---------------------------------------------------------------|-----------------------------------------|



| | | |
|----------------|-------------------------------------------------------------|-----------------------------------------|
| 11-1181 | Messer Elektrode, adaptierbar Knife electrode, adaptable | 330 mm Arbeitslänge working length |
|----------------|-------------------------------------------------------------|-----------------------------------------|



| | | |
|----------------|---------------------------------------------------------------|-----------------------------------------|
| 11-1182 | J-Haken Elektrode, adaptierbar J-hook-electrode, adaptable | 330 mm Arbeitslänge working length |
|----------------|---------------------------------------------------------------|-----------------------------------------|



| | | |
|----------------|------------------------------------------------|-----------------------------------------|
| 11-1183 | Elektrode, adaptierbar Electrode, adaptable | 330 mm Arbeitslänge working length |
|----------------|------------------------------------------------|-----------------------------------------|



| | | |
|----------------|-------------------------------------------------------------|-----------------------------------------|
| 11-1184 | Knopf Elektrode, adaptierbar Button electrode, adaptable | 330 mm Arbeitslänge working length |
|----------------|-------------------------------------------------------------|-----------------------------------------|



| | | |
|----------------|-----------------------------------------------------------|-----------------------------------------|
| 11-1186 | Konus Elektrode, adaptierbar Cone electrode, adaptable | 330 mm Arbeitslänge working length |
|----------------|-----------------------------------------------------------|-----------------------------------------|



| | | |
|----------------|-------------------------------------------------------------------------|-----------------------------------------|
| 11-1187 | Nadel-Elektrode, 5 mm, adaptierbar Needle electrode, 5 mm, adaptable | 330 mm Arbeitslänge working length |
|----------------|-------------------------------------------------------------------------|-----------------------------------------|



| | | |
|----------------|-------------------------------------------------------------------------|-----------------------------------------|
| 11-1187 | Nadel-Elektrode, 5 mm, adaptierbar Needle electrode, 5 mm, adaptable | 330 mm Arbeitslänge working length |
|----------------|-------------------------------------------------------------------------|-----------------------------------------|



| | | |
|----------------|-------------------------------------------------------------------------|-----------------------------------------|
| 11-1187 | Nadel-Elektrode, 5 mm, adaptierbar Needle electrode, 5 mm, adaptable | 330 mm Arbeitslänge working length |
|----------------|-------------------------------------------------------------------------|-----------------------------------------|



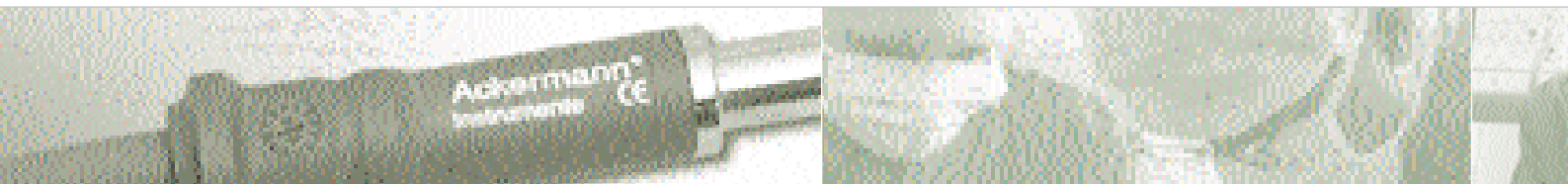

SAUG-SPÜLELEMENTE | SUCTION-IRRIGATION SYSTEMS



11-1171

Trompetenventil für adaptierbare Elektroden
Trumpet valve for adaptable electrodes



11-1172

Ventilkörper für adaptierbare Elektroden
Valve body for adaptable electrodes



11-1173

2 Wege Ventil für adaptierbare Elektroden
Two way valve for adaptable electrodes



11-1174

Pistolengriff für adaptierbare Elektroden
Pistol-handle for adaptable electrodes



11-1176

Trompetenventil für adaptierbare Elektroden
Trumpet valve for adaptable electrodes



11-1177

Trompetenventil für adaptierbare Elektroden
Trumpet valve for adaptable electrodes



BIPOLARE ELEKTRODEN | *BIPOLAR ELECTRODES*



11



| | |
|----------------|---------------------------------------------------------------|
| 11-1190 | Bipolare Schneide-Elektrode <i>Bipolar cut electrodes</i> |
| 11-1191 | Bipolare L-Haken Elektrode <i>Bipolar L-hook electrode</i> |
| 11-1192 | Bipolare Ball-Elektrode <i>Bipolar ball electrode</i> |
| 11-1193 | Bipolare J-Haken Elektrode <i>Bipolar J-hook electrode</i> |
| 11-1194 | Bipolare Nadel-Elektrode <i>Bipolar needle electrode</i> |

PASSENDE KABEL | *SUITABLE CABLES*



| | |
|----------------|------------------------------------------------------------------------------|
| 13-1641 | Bipolares Kabel für US-Generatoren <i>Bipolar cable for US-Generators</i> |
|----------------|------------------------------------------------------------------------------|

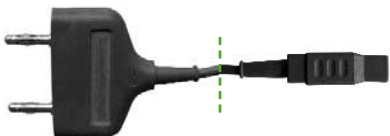

| | |
|------------------|---------------------------------------------------------------------------------------------------------------------------|
| 13-1641VA | Bipolares Kabel für US-Generatoren einschließlich Adapter <i>Bipolar cable for US-Generators with included adapter</i> |
|------------------|---------------------------------------------------------------------------------------------------------------------------|



| | |
|----------------|----------------------------------------------------------------------------------|
| 13-1643 | Bipolares Kabel für ERBE-Generatoren <i>Bipolar cable for ERBE Generators</i> |
|----------------|----------------------------------------------------------------------------------|



| | |
|----------------|--------------------------------------------------------------------------------------------------------------|
| 13-1644 | Bipolares Kabel für Martin / Berchtold Generatoren <i>Bipolar cable for Martin / Berchtold Generators</i> |
|----------------|--------------------------------------------------------------------------------------------------------------|

SAUG-SPÜLELEMENTE | SUCTION-IRRIGATION SYSTEMS



ARBEITSLÄNGE | WORKING LENGTH

330 MM

450 MM



| 330 MM | 450 MM | |
|----------------|-------------------|-------------------------------------------------------------------------------------------------------|
| 11-1215 | 11-1215-45 | Elektroden, Spatel-Spitze, HF-Saug-Kanal Cauteries, spatula tip, HF-port, suction channel |
| 11-1220 | 11-1220-45 | Elektrode, L-Haken-Spitze, HF-Saug-Kanal, Cauteries, L-hook tip, HF-port, suction channel, |
| 11-1225 | 11-1225-45 | Elektrode, Messerspitze, HF-Saug-Kanal Cauteries, knife tip, HF-port, suction channel |
| 11-1230 | 11-1230-45 | Elektrode, J-Hakenspitze, HF-Saug-Kanal Cauteries, J-hook tip, HF-port, suction channel |
| 11-1240 | 11-1240-45 | Elektrode, Saug-Spitze, HF-Saug-Kanal Cauteries, suction coagulation tip, HF-port, suction channel |
| 11-1245 | 11-1245-45 | Elektrode, Nadel-Spitze, HF-Saug-Kanal Cauteries, needle tip, HF-port, suction channel |
| 11-1250 | 11-1250-45 | Elektrode, Konus-Spitze, HF-Saug-Kanal Cauteries, cone tip, HF-port, suction channel |
| 11-1255 | 11-1255-45 | Elektrode, Knopf-Spitze, HF-Saug-Kanal Cauteries, button tip, HF-port, suction channel |

ZUBEHÖR | ACCESSORIES

| | |
|--------------------|----------------------------------------------------------------------------------------|
| 11-1230-100 | Ventilersatzteil Abdeckkappe mit Bohrung Valvesparepart top screw with hole |
| 11-1230-101 | Ventilersatzteil Abdeckkappe ohne Bohrung Valve sparepart bottom screw without hole |
| 11-1230-102 | Ventilersatzteil Drücker Valve sparepart plunger |
| 11-1230-103 | Ventilersatzteil Feder Valve sparepart spring |



CHOLANGIOGRAM INSTRUMENTE | CHOLANGIOGRAM INSTRUMENTS



11

11-1249 Cholangiogram Zange, Ø 5 mm, mit Sperre, *Cholangiogram forceps, Ø 5 mm, with ratchet,* 330 mm
Arbeitslänge | *working length*



11-1680 Leitkanüle für Katheter, 360 mm
Guide tube for catheter, 360 mm



11-1681 Leithaken für Katheter, 5 mm
Guide hook for catheter, 5 mm

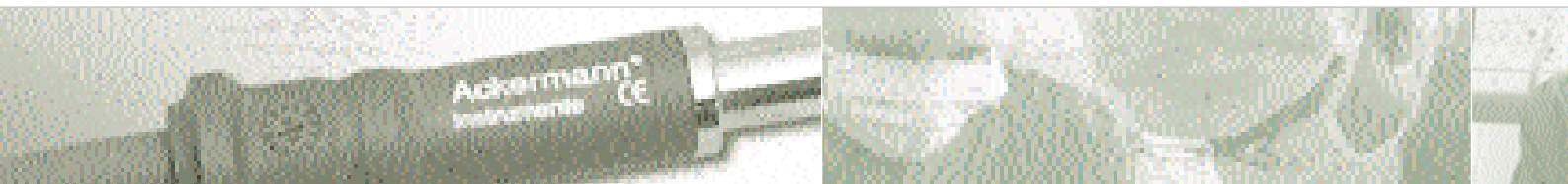

MONOPOLARE KABEL | *MONOPOLAR CABLES*



Ø 4 mm

10-1260

HF-Kabel für alle Ackermann Instrumente, monopolarer Gebrauch, Geräteanschluss 4 mm
HF-cable to all Ackermann Instruments, monopolar use, generatorside

10-1260-3

HF-Kabel für alle Ackermann Instrumente, monopolarer Gebrauch, 3 Meter
HF-cable to all Ackermann Instruments, monopolar use, 3 meters



Ø 5 mm

11-1261

HF-Kabel für alle Ackermann Instrumente, monopolarer Gebrauch, Geräteanschluss 5 mm
HF-cable to all Ackermann Instruments, monopolar use, generatorside



Ø 8 mm

11-1262

HF-Kabel für alle Ackermann Instrumente, monopolarer Gebrauch, Geräteanschluss 8 mm Bovie
HF-cable to all Ackermann Instruments, monopolar use, generatorside



11-1260UR

HF-Kabel für Urologie, und monopolaren Gebrauch, Geräteanschluss 4 mm
HF-cable for Urology, and monopolar use, generatorside

11-1261UR

HF-Kabel für Urologie, und monopolaren Gebrauch, Geräteanschluss 5 mm
HF-cable for Urology, and monopolar use, generatorside

11-1262UR

HF-Kabel für alle Ackermann Instrumente, monopolarer Gebrauch, Geräteanschluss* 8 mm Bovie
*HF-cable to all Ackermann Instruments, monopolar use, generatorside**

* Urologie | *Urology*



SAUG-SPÜLELEMENTE | SUCTION-IRRIGATION SYSTEMS



| | | |
|--------------------|-----------------------------------------------------------------------------------------|----|
| 11-1235 | Saug-Spül-System mit Trompetenventilen Suction irrigation system with trumpet valves | 11 |
| 11-1235-100 | 5 mm Rohr für 11-1235 5 mm tubes for 11-1235 | |
| 11-1235-101 | 10 mm Rohr für 11-1235 10 mm tubes for 11-1235 | |
| 11-1235-102 | Ventilgrundkörper ohne Rohre Valve body without tubes | |



SAUG-SPÜLELEMENTE | SUCTION-IRRIGATION SYSTEMS

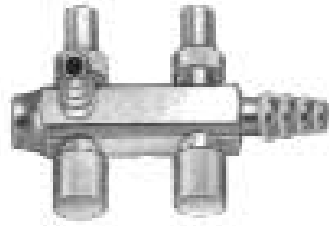

SCHÄFTE BITTE GESONDERT BESTELLEN | PLEASE ORDER SHEATHS SEPARATE

11-1236

Modularer Saugspülgriff für 5 mm und 10 mm Rohre
Modular suction and irrigation handle for 5 mm and 10 mm sheaths

11-1236COM

Modularer Saugspülgriff für 5 mm und 10 mm Rohre, einschl. **11-1237** und **11-1238**
Mod. suction and irrigation handle for 5 and 10 mm sheaths, incl. 11-1237 and 11-1238



11-1237-3

3 mm Schaft,
3 mm sheath,

für | for
11-1236

11-1237-700

3 mm Schaft, mit 12 Bohrungen,
3 mm sheath, with 12 holes

für | for
11-1236

11-1237

5 mm Schaft,
5 mm sheath,

für | for
11-1236

11-1237-100

5 mm Schaft mit vielen Bohrungen,
5 mm sheath with excessive holes,

für | for
11-1236

11-1237-200

5 mm Schaft mit vielen Bohrungen, Spitze eingezogen,
5 mm sheath with excessive holes tip rounded off,

für | for
11-1236

11-1237-300

5 mm Schaft mit vielen Bohrungen, Spitze stark eingezogen,
5 mm sheath with excessive holes tip strongly rounded off,

für | for
11-1236

11-1237-400

5 mm Schaft, Nadel-Form,
5 mm sheath, needle form,

für | for
11-1236

11-1237-500

5 mm Schaft, Micro Spitze,
5 mm sheath, micro tip,

für | for
11-1236

11-1237-600

5 mm Schaft, verjüngte Spitze,
5 mm sheath, tapered tip,

für | for
11-1236

11-1237-800

5 mm Schaft,
5 mm sheath,

für | for
11-1236



11-1238

10 mm Schaft,
10 mm sheath,

für | for
11-1236



SAUG-SPÜLEMENTE | SUCTION-IRRIGATION SYSTEMS



11

11-1236D

Modularer Saugspülgriff für 5 mm und 10 mm Rohre, einmalverwendbar mit Schlauchset
Modular suction and irrigation handle for 5 mm and 10 mm sheaths with tubing set



11-1237D

5 mm Schaft, mehrfachverwendbar,
5 mm sheath, reusable,

für | for
11-1236D

11-1238D

10 mm Schaft, mehrfachverwendbar,
10 mm sheath, reusable,

für | for
11-1236D



11-1275D

2 Weg Saug-Spül-System mit Trompetenventilen einmalverwendbar mit Schlauchset
Two-way suction and irrigating system with trumpet valves, disposable with tube set

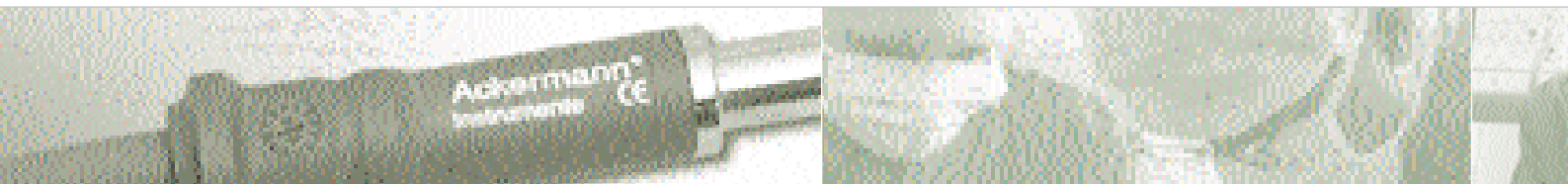

SAUG-SPÜLEMENTE | SUCTION-IRRIGATION SYSTEMS

11-1266

Saug-Spül-System für Austauschschaft
Suction irrigation system for exchangeable sheath



11-1267

Saug-Spül-System für Austauschschaft
Suction irrigation system for exchangeable sheath



11-1268

Saug-Spül-System für Austauschschaft-Pistolen-Griff
Suction irrigation system for exchangeable sheath, pistol handle



11-1271

Adaptierbare Saugschäfte
Adaptable suction sheaths

5 mm



11-1272

Adaptierbare Saugschäfte
Adaptable suction sheaths

10 mm





SAUG-SPÜLELEMENTE | SUCTION-IRRIGATION SYSTEMS



11

| | | |
|-----------------|----------------------------------------------------------------|-------|
| 11-1269 | Zwei-Wege-Ventil adaptierbar <i>Two way valve adaptable</i> | |
| 11-1271L | Schäfte, <i>Sheaths,</i> | 5 mm |
| 11-1272L | Schäfte, <i>Sheaths,</i> | 10 mm |



| | | |
|-------------------|------------------------------------------------------------|---------------|
| 11-1270 | Saugkanüle mit Hahn, <i>Suction tube with stopcock,</i> | 5 mm x 330 mm |
| 11-1270-3 | Saugkanüle mit Hahn, <i>Suction tube with stopcock,</i> | 3 mm x 330 mm |
| 11-1270-45 | Saugkanüle mit Hahn, <i>Suction tube with stopcock,</i> | 5 mm x 450 mm |

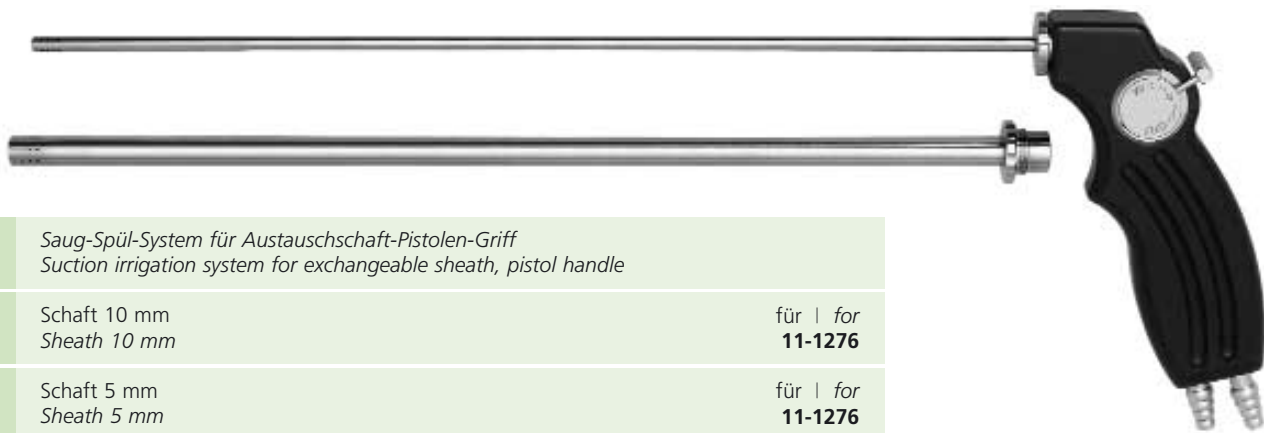

| | | |
|----------------|---------------------------------------------------------------------------------------------------------------------------------|-----------------------------|
| 11-1276 | Saug-Spül-System für Austauschschacht-Pistolen-Griff <i>Suction irrigation system for exchangeable sheath, pistol handle</i> | |
| 11-1277 | Schaft 10 mm <i>Sheath 10 mm</i> | für for 11-1276 |
| 11-1278 | Schaft 5 mm <i>Sheath 5 mm</i> | für for 11-1276 |

| | | |
|----------------|-----------------------------------------------|-----------------------------|
| 11-1279 | Elektrodenadapter <i>Electrode-adaptor</i> | für for 11-1276 |
|----------------|-----------------------------------------------|-----------------------------|



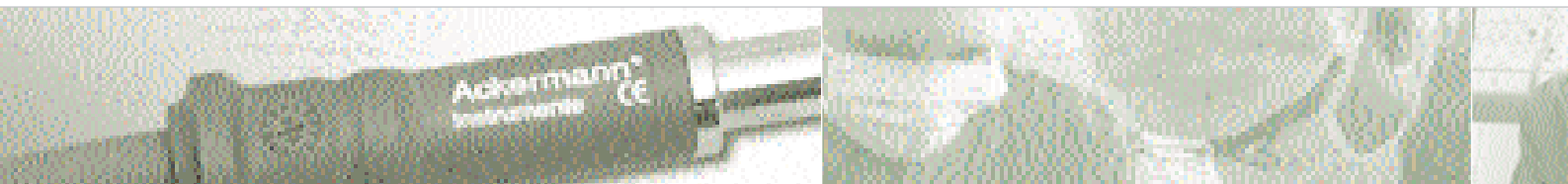

SAUG-SPÜLELEMENTE | SUCTION-IRRIGATION SYSTEMS



11-1275

2 Weg Saug-Spül-System mit Trompetenventilen
Two-way suction and irrigating system with trumpet valves

11-1275-3

2 Weg Saug-Spül-System mit Trompetenventilen,
Two-way suction and irrigating system with trumpet valves,

3 mm Version
3 mm version



11-1265

Absaugkanüle für Laserfiber
Irrigating aspirating cannula, channel for laser fibre



11-1251

Gallenblasenextractor
Gall bladder extractor

ACKERMANN INSTRUMENTE GmbH, GERMANY
Eisenbahnstraße 65-67
78604 Rietheim-Weilheim

Phone: ++49 (0) 74 61 / 9 66 17-0
Fax: ++49 (0) 74 61 / 9 66 17-70

info@ackermanninstrumente.de
www.ackermanninstrumente.de